

PC board pin-out

Item:LESM0400R9P5DV0E

Normal Mode Choke Coil

[mm]

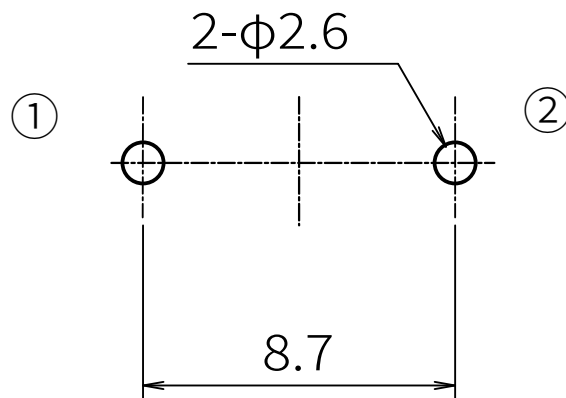

Wire: $\phi 2.0$ -1P

Wiring Diagram

