



No.U21H100002-77

PC board pin-out

Item:LDFW036262Y28V0E

Common mode Choke Coil (Single Phase)

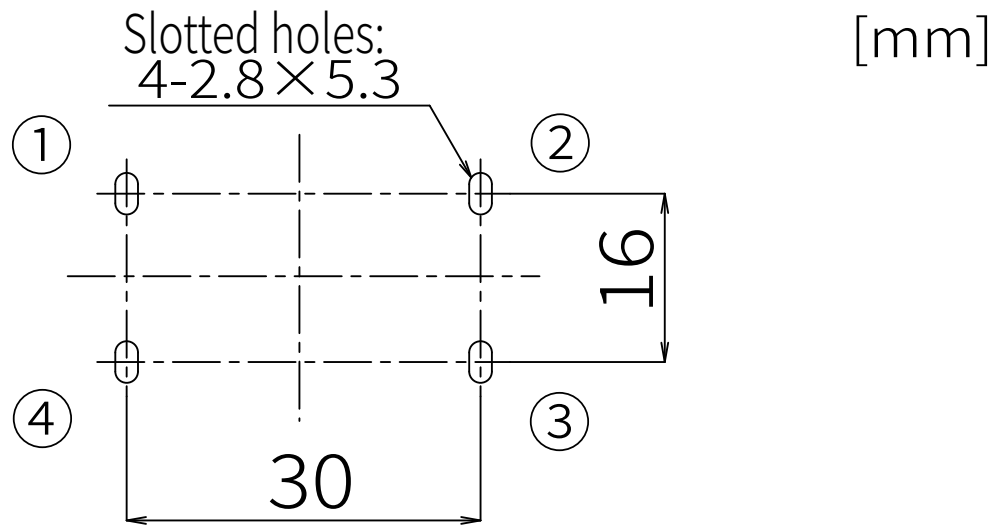

Wire: $\phi 2.2$ -2P

Wiring Diagram

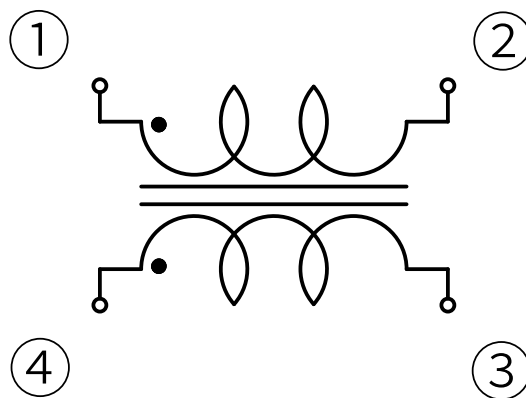

NIPPON CHEMI-CON CORPORATION