

PC board pin-out

Item:LDFL025252LJUV0E

Common mode Choke Coil (Single Phase)

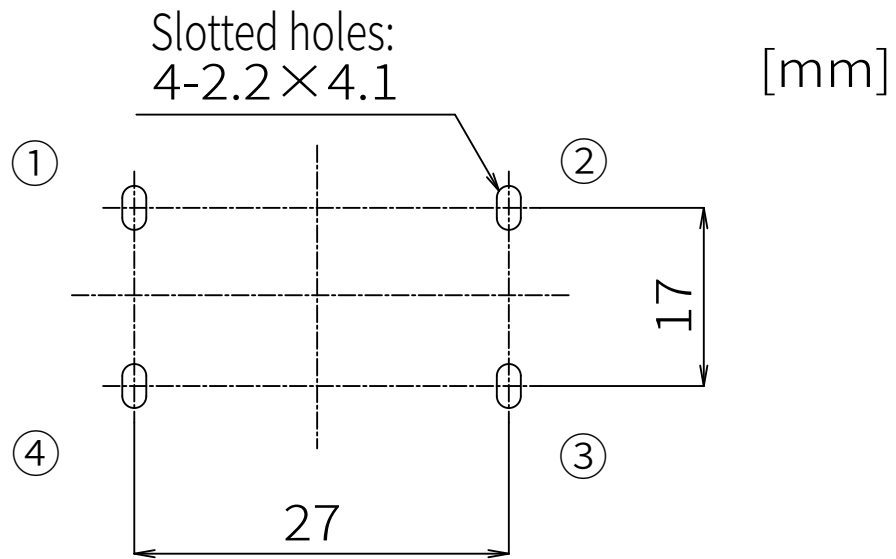

Wire: $\phi 1.6$ -2P

Wiring Diagram

