

### ◆ MAJOR USES

- For PFC Normal mode noise filter

### ◆ FEATURES

- Exhibits excellent DC superimposition characteristics of inductance and achieved significant miniaturization
- Reduced iron loss when compared to the CM Series
- Low temperature rise even when using 100V or higher
- Excellent temperature stability

### ◆ CORE STANDARD SPECIFICATIONS

Core Part No. (Old Core Part No.)	Abbreviation	Cross Sectional Area cm <sup>2</sup>	Magnetic Path Length cm	Outside Dimensions			Inductance Coefficient AL Value		
				Outer Diameter mm	Width mm	Height mm	I <sub>dc</sub> =0[A] μH	Rated Current* μH	Rated Current Ampere Turn [AT]
LNC251510J3 (C251510J3)	J7H	0.430	6.28	28.3	12.7	12.3	0.100	0.075	430
LNC251515J2 (C251515J2)	J8H	0.645	6.28	28.3	12.7	17.5	0.140	0.113	460
LNC322015J2 (C322015J2)	JRH	0.774	8.17	35.2	17.5	17.3	0.122	0.102	600
LNC322020J2 (C322020J2)	JAH	1.032	8.17	35.5	17.0	23.8	0.156	0.125	660
LNC372320J2 (C372320J2)	JBH	1.204	9.42	40.5	19.5	23.0	0.173	0.140	700
LNC462720J2 (C462720J2)	JCH	1.634	11.50	49.4	22.7	23.0	0.191	0.156	840
LNC462725J2 (C462725J2)	JKH	2.043	11.50	49.4	22.7	28.0	0.230	0.183	900
LNC603525J2 (C603525J2)	JLH	2.688	14.90	66.7	29.3	29.2	0.230	0.166	1300

\*100[kHz], ±25%

### ◆ CORE LOSS CHARACTERISTICS

- AM choke

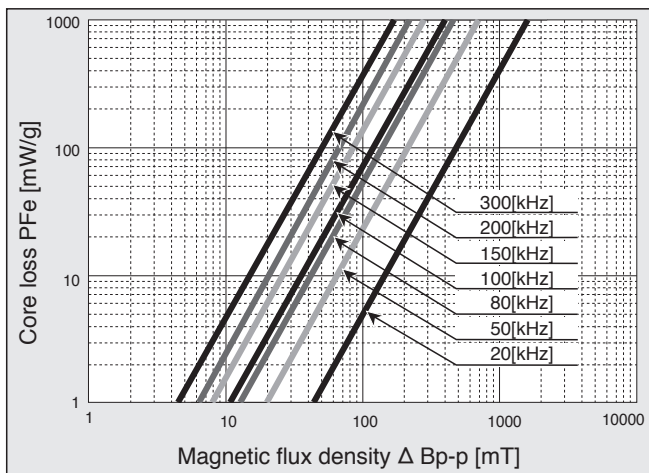

◆ D.C. BIAS CHARACTERISTICS AL-AT(1)

● Frequency : 100[kHz]

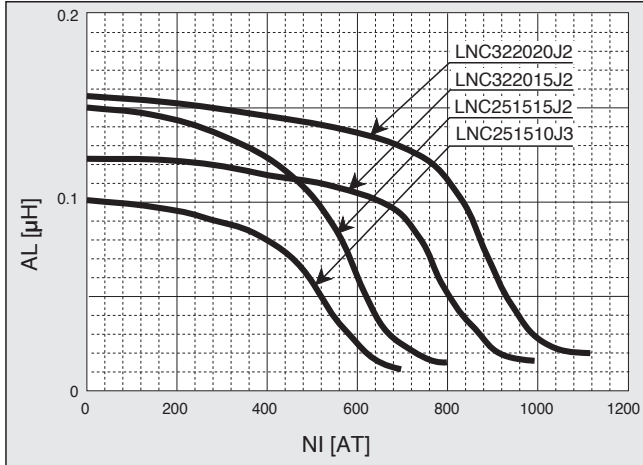

◆ D.C. BIAS CHARACTERISTICS AL-AT(2)

● Frequency : 100[kHz]

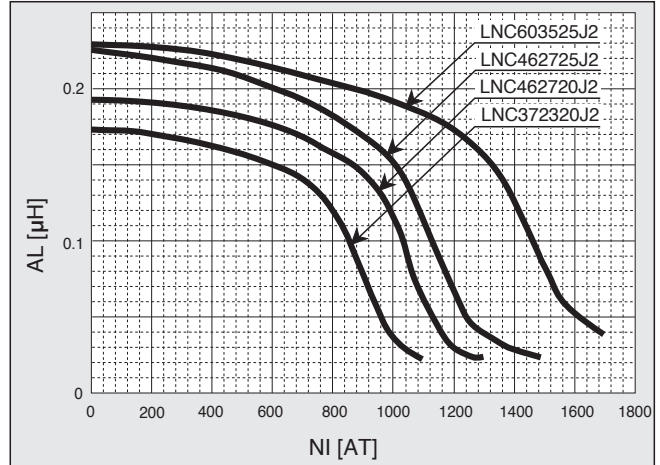

◆ FREQUENCY - INDUCTANCE CHARACTERISTICS

● AM choke

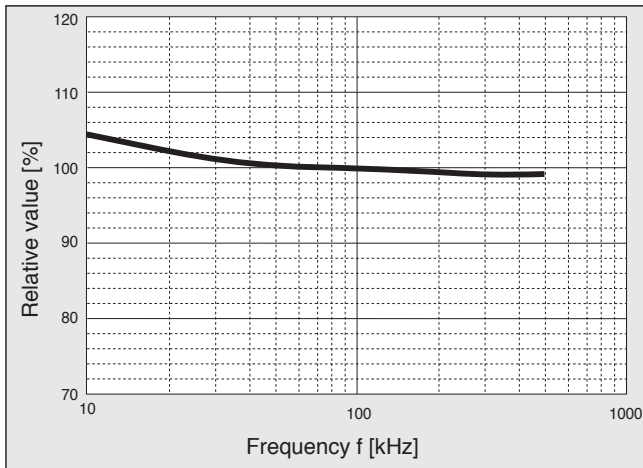

◆ TEMPERATURE DEPENDENCE

- INDUCTANCE AND CORE LOSS

● Frequency : 100[kHz]

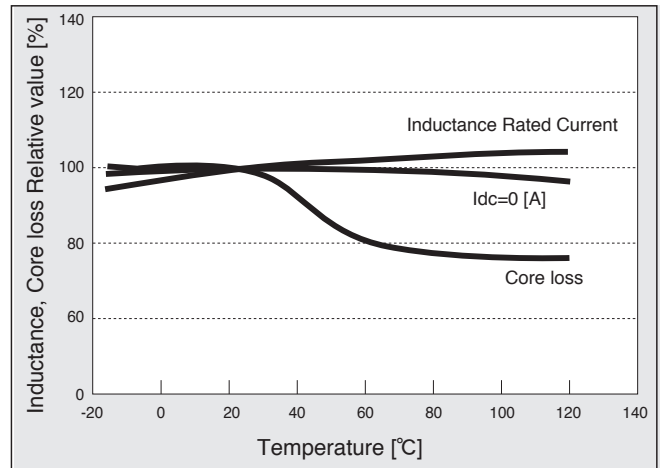

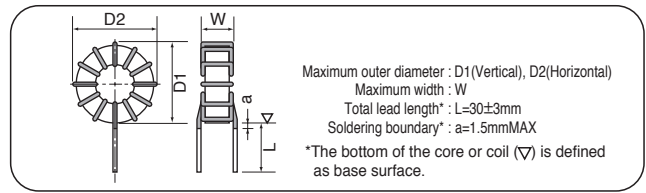

### ◆ COIL STANDARD SPECIFICATIONS

Coil Part No. (Old Coil Part No.)	Rated Current Arms	Peak Current A	Inductance (100kHz)		D.C.R. mΩ (max)	Winding mmφ×Lines	Outside Dimensions		
			0[A] μH	Rating μH			D1 mm	D2 mm	W mm
○ LAAM002202J7HV0E (AM02202J7HPBF)	2	2.8	2400 <sup>*2</sup>	2000 <sup>*2</sup>	350	0.7×1P	33.0	34.5	19.0
○ LAAM003901J7HV0E (AM03901J7HPBF)	3	4.2	1100	900	170	0.9×1P	33.0	34.5	19.5
○ LAAM003152J8HV0E (AM03152J8HPBF)	3	4.2	2000	1500	230	0.85×1P	35.5	35.5	26.0
○ LAAM004801J8HV0E (AM04801J8HPBF)	4	5.7	1100	800	150	0.9×1P	34.0	34.0	25.5
○ LAAM005501J8HV0E (AM05501J8HPBF)	5	7.1	600	500	80	1.1×1P	34.5	34.5	28.0
○ LAAM004102JRHV0E (AM04102JRHPBF)	4	5.7	1200	1000	160	1.0×1P	40.5	42.0	26.5
○ LAAM005751JRHV0E (AM05751JRHPBF)	5	7.1	890	750	110	1.1×1P	40.5	42.0	27.0
○ LAAM005901JAHV0E (AM05901JAHPBF)	5	7.1	1000	900	115	1.1×1P	40.5	42.0	32.0
○ LAAM006651JAHV0E (AM06651JAHPBF)	6	8.5	740	650	87	1.2×1P	41.0	42.5	32.5
○ LAAM005122JBHV0E (AM05122JBHPBF)	5	7.1	1500	1200	140	1.1×1P	45.5	47.0	31.5
○ LAAM006801JBHV0E (AM06801JBHPBF)	6	8.5	970	800	94	1.2×1P	45.0	46.5	30.5
○ LAAM008501JBHV0E (AM08501JBHPBF)	8	11.3	600	500	53	1.0×2P	46.5	48.0	32.0
○ LAAM008801JCHV0E (AM08801JCHPBF)	8	11.3	1000	800	73	1.0×2P	56.0	57.5	33.5
○ LAAM010501JCHV0E (AM10501JCHPBF)	10	14.1	600	500	45	1.1×2P	54.5	56.0	32.5
○ LAAM012351JCHV0E (AM12351JCHPBF)	12	17.0	420	350	33	1.2×2P	55.0	56.5	32.0
○ LAAM010651JKHV0E (AM10651JKHPBF)	10	14.1	840	650	53	1.1×2P	56.0	57.5	38.0
○ LAAM012451JKHV0E (AM12451JKHPBF)	12	17.0	590	450	41	1.2×2P	55.5	57.0	38.0
○ LAAM015301JKHV0E (AM15301JKHPBF)	15	21.2	380	300	26	1.1×3P	55.5	57.0	38.0
○ LAAM012701JLHV0E (AM12701JLHPBF)	12	17.0	860	700	53	1.2×2P	72.5	74.0	39.0
○ LAAM015451JLHV0E (AM15451JLHPBF)	15	21.2	550	450	35	1.1×3P	72.0	73.5	40.0
○ LAAM020251JLHV0E (AM20251JLHPBF)	20	28.3	310	250	20	1.1×4P	72.5	74.0	39.0

\*1 Rated inductance tolerance : ±25%, the inductance at current 0[A] indicates the reference value.

\*2 LAAM002202J7HV0E : 10kHz.

There is a horizontal putting type in all items in the above list. "V" changes into "H" in last the third digit of the name of items.

There are the type with the length putting seat and the horizontal putting seat in ○ item.

\*Order the auxiliary pins separately if they are required for the pedestal.

Please select them according to the situation.

◆D.C. BIAS CHARACTERISTICS (1)

●Core : LNC251510J3, LNC251515J2, LNC322015J2,  
Frequency : 100[kHz]

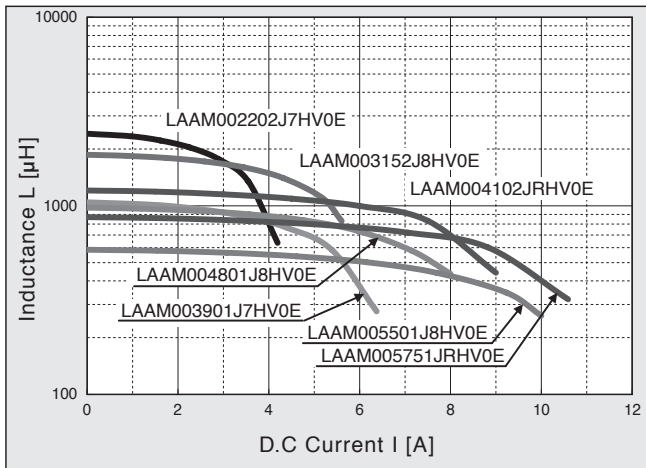

◆D.C. BIAS CHARACTERISTICS (2)

●Core : LNC322020J2, LNC372320J2, Frequency : 100[kHz]

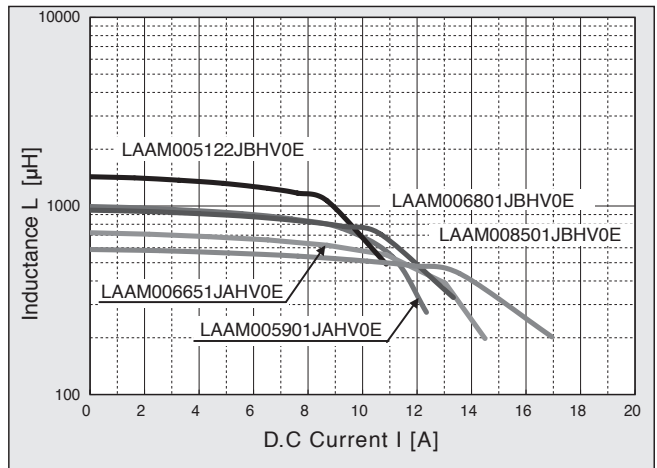

◆D.C. BIAS CHARACTERISTICS (3)

●Core : LNC462720J2, Frequency : 100[kHz]

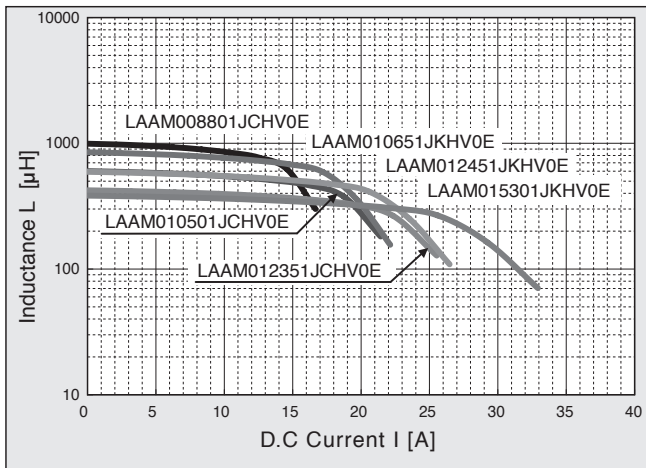

◆D.C. BIAS CHARACTERISTICS (4)

●Core : LNC603525J2, Frequency : 100[kHz]

