

TAPING SPECIFICATIONS

SURFACE MOUNT TYPE (TAPING)



◆CARRIER TAPE [mm]

Fig.1

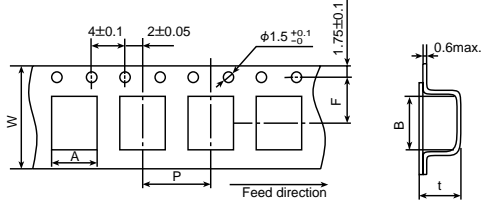

Fig.3

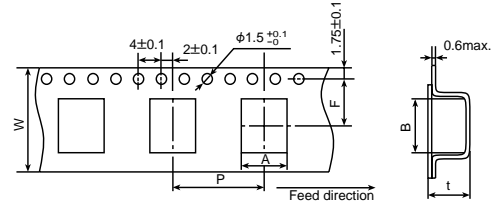

Fig.2

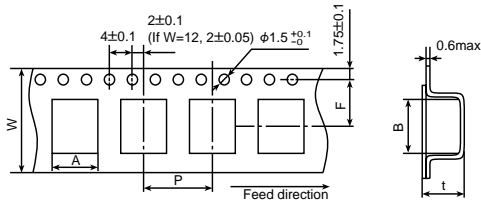
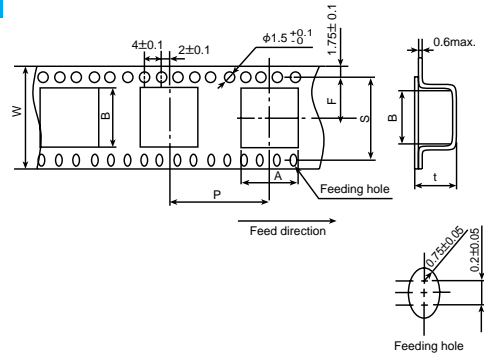

Fig.4



[mm]

Series	Items	W	A	B	F	P	t	S	Fig.
		±0.3	±0.2	±0.2	±0.1	±0.1	±0.2	±0.1	
Alchip™ MVS/MVA MV/MVE MVK/MZJ MZA/MVY MZF/MZE MZK/MLA MLF/MLE MLK/MVL MVJ/MVH MHB/MKB MV-BP MVK-BP	D46	12.0	4.7	4.7	5.5	8.0	4.9	—	1
	D55	12.0	4.7	4.7	5.5	8.0	5.7	—	1
	D60,D61	12.0	4.7	4.7	5.5	8.0	6.3	—	1
	D73	12.0	4.6	4.6	5.5	8.0	7.5	—	1
	E46	12.0	5.7	5.7	5.5	12.0	4.9	—	2
	E55	12.0	5.7	5.7	5.5	12.0	5.7	—	2
	E60,E61	12.0	5.7	5.7	5.5	12.0	6.3	—	2
	E73	16.0	5.7	5.7	7.5	12.0	7.5	—	2
	F45	16.0	7.0	7.0	7.5	12.0	4.8	—	2
	F46	16.0	7.0	7.0	7.5	12.0	4.9	—	2
	F55	16.0	7.0	7.0	7.5	12.0	5.7	—	2
	F60,F61	16.0	7.0	7.0	7.5	12.0	6.3	—	2
	F73	16.0	7.0	7.0	7.5	12.0	7.5	—	2
	F80	16.0	7.0	7.0	7.5	12.0	8.2	—	2
	F90	16.0	7.0	7.0	7.5	12.0	9.2	—	2
	H63	16.0	8.7	8.7	7.5	12.0	6.8	—	2
	H70	24.0	8.7	8.7	11.5	12.0	7.3	—	2
	H80	24.0	8.7	8.7	11.5	12.0	8.3	—	2
	HA0	24.0	8.7	8.7	11.5	16.0	11.0	—	3
	NPCAP™ P XK/PXS PXF/PXE PXA/PXH	HC0	24.0	8.7	8.7	11.5	16.0	12.7	—
J80		24.0	10.7	10.7	11.5	16.0	8.3	—	3
JA0		24.0	10.7	10.7	11.5	16.0	11.0	—	3
JC0		24.0	10.7	10.7	11.5	16.0	12.8	—	3
KE0		32.0	13.4	13.4	14.2	24.0	14.0	28.4	4
KG5		32.0	13.4	13.4	14.2	24.0	16.5	28.4	4
LH0		44.0	17.5	17.5	20.2	28.0	16.8	40.4	4
LN0		44.0	17.5	17.5	20.2	28.0	22.1	40.4	4
MH0		44.0	19.5	19.5	20.2	32.0	17.1	40.4	4
MN0		44.0	19.5	19.5	20.2	32.0	22.1	40.4	4

◆ REEL DIMENSIONS [mm]

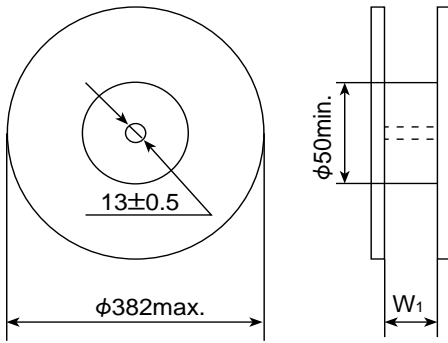

◆ POLARITY

- Alchip™- MVS/MVA/MV
MVE/MVK/MZJ
MZA/MVY/MZF
MZE/MZK/MLA
MLF/MLE/MLK
MVL/MVJ/MVH
MHB/MKB
MV-BP/MVK-BP
NP CAP™ P XK/PXS/PXF
PXE/PXA/PXH

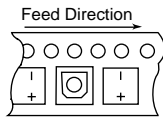

◆ QUANTITY PER REEL/BOX

Series	Size code	Quantity (pcs/reel)	Quantity (pcs/box)	W ₁ (mm)
Alchip™	D46,D55,D60,D61	2,000	10,000	14
	D73	1,500	7,500	14
	E46,E55,E60,E61	1,000	5,000	14
	E73	1,000	5,000	18
	F46,F55,F60,F61,F73	1,000	5,000	18
	F80	900	4,500	18
	F90	800	4,000	18
	H63	1,000	5,000	18
	HA0	500	1,500	26
	JA0	500	1,500	26
	KE0	200	600	34
	KG5	150	450	34
	LH0	125	250	46
	LN0	75	150	46
	MH0	125	250	46
	MN0	75	150	46
NPCAP™	D55	2,000	20,000	14
	E60,E61	1,000	10,000	14
	F45,F55,F60,F61	1,000	7,000	18
	F80	900	6,300	18
	H70	1,000	6,000	26
	H80	900	5,400	26
	HA0	500	3,000	26
	HCO	400	1,200	26
	J80	500	3,000	26
	JA0	500	3,000	26
JCO	400	1,200	26	

SURFACE MOUNT TYPE (TRAY)

◆ DIMENSIONS [mm]

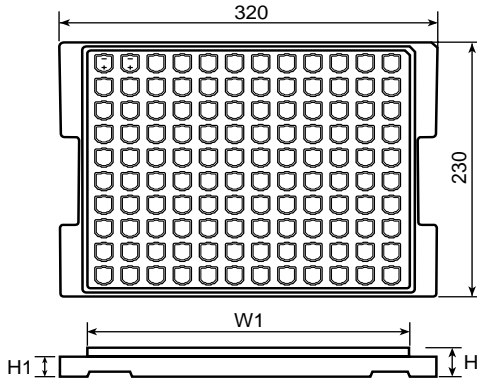

● TRAY CODE : TR

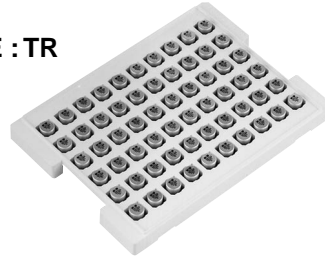

Size code	H [mm]	W ₁ [mm]	H ₁ [mm]	Quantity [pcs/tray]	Quantity [pcs/box]
KE0 & KG5	21.0	284	18.5	120	600
LH0 & LN0	28.0	284	24.0	80	400
MH0 & MN0	28.0	284	24.0	60	300

VIBRATION RESISTANT STRUCTURE (Terminal code : G)

◆ DIMENSIONS [mm]

- Terminal code : G
- Size code : HA0 to JA0

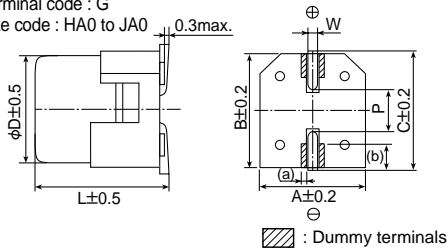

◆ RECOMMENDED SOLDER LAND

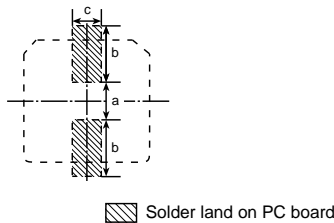

- Size code : KE0 to MN0

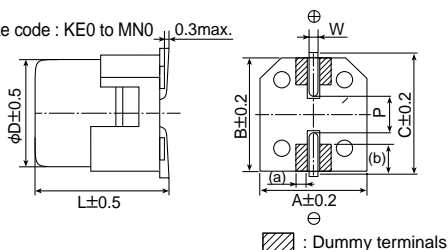

Size code	Dimensions of products (mm)									Solder land (mm)		
	D	L	A	B	C	W	P	(a)	(b)	a	b	c
HA0	8.0	10.0	8.3	8.3	9.0	0.7 to 1.1	3.1	(0.5)	(1.8)	3.1	4.2	3.5
JA0	10.0	10.0	10.3	10.3	11.0	0.7 to 1.1	4.5	(0.5)	(2.1)	4.5	4.4	3.5
KE0	12.5	13.5	13.0	13.0	13.7	1.0 to 1.3	4.2	(1.3)	(3.0)	3.4	6.3	9.3
KG5	12.5	16.0	13.0	13.0	13.7	1.0 to 1.3	4.2	(1.3)	(3.0)	3.4	6.3	9.3
LH0	16.0	16.5	17.0	17.0	18.0	1.0 to 1.3	6.5	(2.0)	(3.0)	4.7	7.8	9.6
LN0	16.0	21.5	17.0	17.0	18.0	1.0 to 1.3	6.5	(2.0)	(3.0)	4.7	7.8	9.6
MH0	18.0	16.5	19.0	19.0	20.0	1.0 to 1.3	6.5	(2.0)	(4.0)	4.7	8.8	9.6
MN0	18.0	21.5	19.0	19.0	20.0	1.0 to 1.3	6.5	(2.0)	(4.0)	4.7	8.8	9.6

() ; Ref.

TAPING SPECIFICATIONS
RADIAL LEAD TYPE (TAPING)



◆DIMENSION [mm]

Fig.1

Taping Code : TA, TC
φD=φ4 to 8

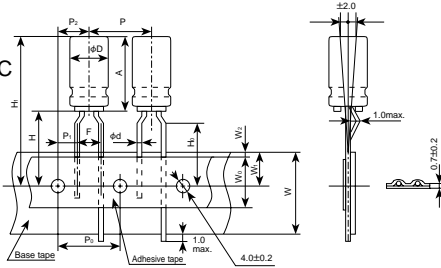

Fig.2

Taping Code : TD
φD=φ5
φD×L=φ4×7

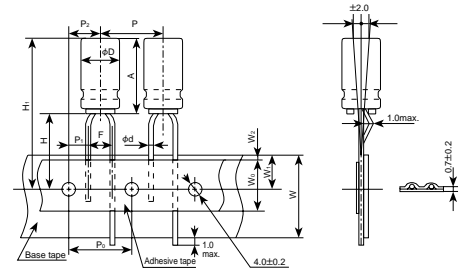

Fig.3

Taping Code : TD
φD=φ6.3 to 12.5

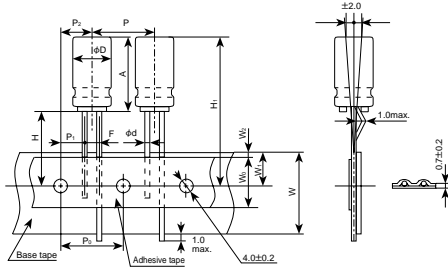
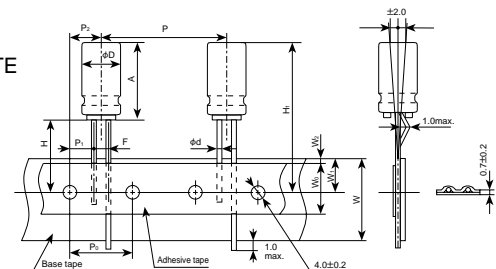

Fig.4

Taping Code : TE
φD=φ12.5



Code	Taping Code	Case size		φd	P	P ₀	P ₁	P ₂	F	W	W ₀	W ₁	W ₂	H	H ₀	H ₁	Fig.	
		φD	A															
tol.		—	—	±0.05	±1.0	±0.2	±0.7	±1.0	+0.8 -0.2	±0.5	min.	±0.5	max.	±0.75	±0.5			
Nominal	TA	4	5	0.45	12.7	12.7	5.1	6.35	2.5	18.0	6.0	9.0	1.5	17.5	16.0	H ₁ =H+A	Check insertion machine specs.	1
	TC						3.85											5
	TD		5.1	5	1													
	TC		3.85	5	1													
	TD	11.5	0.45	12.7	12.7	5.1	6.35	2.5	18.0	10.0	9.0	1.5	17.5	16.0	2			
	TC					3.85									5			1
	TD	5	5 to 7	0.45	12.7	12.7	5.1	6.35	2.5	18.0	6.0	9.0	1.5	18.5	16.0			2
	TC						3.85											5
	TD		9 to 15	0.5	12.7	12.7	5.1	6.35	2.5	18.0	10.0	9.0	1.5	18.5	16.0			2
	TC						3.85											5
	TD	6.3	5 to 7	0.45	12.7	12.7	5.1	6.35	2.5	18.0	6.0	9.0	1.5	17.5	16.0			3
	TC						3.85											5
TD	9 to 15		0.5	12.7	12.7	5.1	6.35	2.5	18.0	10.0	9.0	1.5	18.5	16.0	3			
TC						3.85									5	1		
TD	8	5	0.45	12.7	12.7	5.1	6.35	2.5	18.0	6.0	9.0	1.5	18.5	16.0	3			
TC						3.85									5	1		
TD		7	0.45	12.7	12.7	3.85	6.35	5	18.0	6.0	9.0	1.5	17.5	16.0	1			
TC						3.85									5	1		
TD	9 to 20	0.6	12.7	12.7	3.85	6.35	3.5	18.0	10.0	9.0	1.5	20.0	16.0	1				
TC					3.85									5	1			
tol.		±0.5	max.	±0.05	±1.0	±0.3	±0.7	±1.3	+0.8 -0.2	±0.5	min.	±0.5	max.	+2.0 -0				
Nominal	TD	10	21	0.6	12.7	12.7	3.85	6.35	5	18.0	12.5	9.0	1.5	18.0	—		3	
	TD	12.5	26	0.6	15	15	5.0	7.5	5	18.0	12.5	9.0	1.5	18.0	—		3	
	TE			0.6	25.4	12.7	3.85	6.35	5	18.0	12.5	9.0	1.5	18.0	—		4	

* 1 : For φ4×7 (A=7, F=25), shall be 18.5^{-0.5/+0.75} (Taping code : TD) at Fig.2.

* 2 : P=15 taping is not standard. Use P=25.4 taping.

TAPING CODE

Example

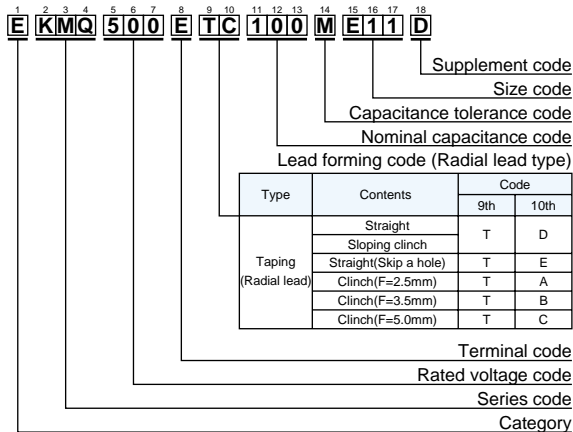

QUANTITY PER AMMO PACK

Ammo pack box

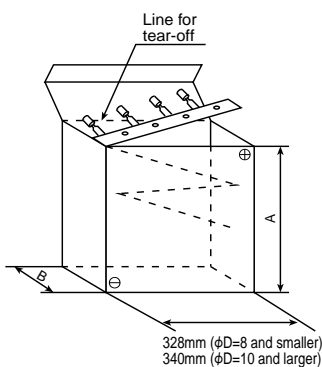

Typical example

φD	Case size φD × L(mm)		A (mm)	B (mm)	Quantity (pcs.)
	L=5 & 7mm	L=9 to 15mm			
φ4	L=5 & 7mm	183	42	2,000	
	L=9 to 15mm	183	51		
φ5	L=5 & 7mm	232	42	2,000	
	L=9 to 15mm	232	51		
φ6.3	L=5 & 7mm	235	60	2,000	
	L=9 to 15mm	235	60		
φ8	L=5 & 7mm	282	42	1,000	
	L=9 to 15mm	282	51		
φ10	L=5 & 7mm	308	56	800(500)*	
	L=9 to 15mm	308	62		
	L=17 to 20mm	308	67		
	L=21 to 25mm	308	71		
φ12.5	L=5 & 7mm	308	62	500	
	L=9 to 15mm	308	67		

*Minimum order quantity for PSK/PSF/PSE/PSC/PSA/PS series

RADIAL LEAD TYPE (CUT/FORMED LEAD)

The following lead configurations are available. When ordering, please indicate the type of lead configurations by using the appropriate supplement code, such as C5, FC, MC or RC in the product part number.

[mm]

●Lead code : C5

$\phi D=4$ to 18

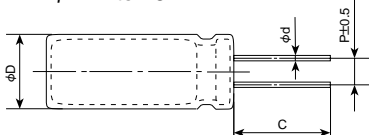

Case diameter C:Lead length

$\phi D=4$ to 8 : 5.0 ± 0.5

$\phi D=10$ to 18 : $5.0^{+1.0}_{-0}$

●Lead code : C3

$\phi D=4$ to 18

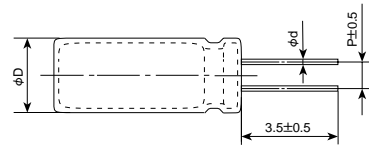

●Lead code : FC

$\phi D=5$ to 8

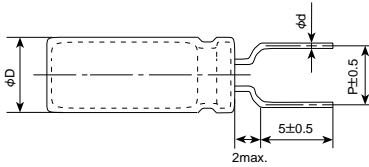

●Lead code : FM

$\phi D=5$ to 8

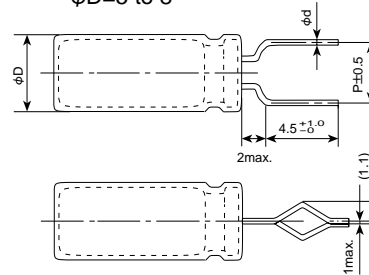

●Lead code : MC

$\phi D=10$ to 18

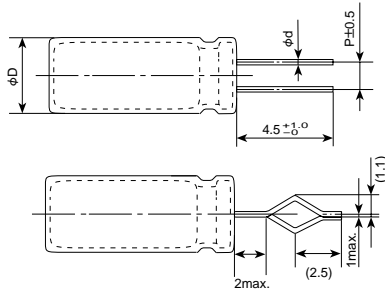

●Lead code : RC

$\phi D=20$ & 22

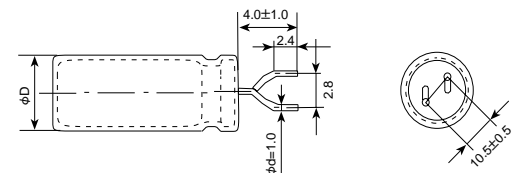

●Lead code : BC

$\phi D=10, 12.5$: $P=5.0 \pm 0.5$

$\phi D=14.5, 16, 18$: $P=7.5 \pm 0.5$

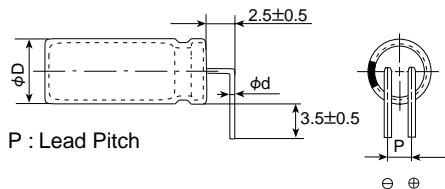



PACKAGING

MINIMUM ORDER QUANTITY

Please order by minimum order quantity.

◆SURFACE MOUNT

●Vertical



Series	Size code	Quantity (pcs)	
		Taping	Tray (pcs/box)
Alchip™ MVS/MVA/MV MVE/MVK/MZJ MZA/MVY/MZF MZE/MZK/MLA MLF/MLE/MLK MVL/MVJ/MVH MHB/MKB MV-BP/MVK-BP NPCAP™ PXK/PXS/PXF PXE/PXA/PXH	D46, D55, D60, D61	2,000	—
	D73	1,500	—
	E46, E55, E60, E61, E73	1,000	—
	F45, F46, F55, F60, F61, F73	1,000	—
	F80, H80	900	—
	F90	800	—
	H63, H70	1,000	—
	HA0	500	—
	HC0	400	—
	J80, JA0	500	—
	JC0	400	—
	KE0	200	600
	KG5	150	600
	LH0	125	400
	LN0	75	400
	MH0	125	300
	MN0	75	300

◆RADIAL



Size	Quantity (pcs)	
	Bagged*1	Taping
φ4	200	2,000
φ5	200	2,000
φ6.3	200 (200)*2	2,000 (2,000)*2
φ8	200 (100)*2	1,000 (1,000)*2
φ10	Height ≤ 25mm	200 (100)*2
	Height ≥ 30mm	200
φ12.5	100	500
φ14.5	50	250
φ16	50	250
φ18	50	250

*1 Standard bagged quantity.

*2 Minimum order quantity for PSK/PSF/PSE/PSC/PSA/ PS series.

◆SNAP-IN



200 pieces